

Jupiter 2.50"

Beam Adjustable Cylinder - White

Product Information

Color temp	27,30,35,41,50k
Output lumens	1000
Beam angle	20-55°
Input volts	120-277V
Wattage	12W
Height	4.31"
Width	2.56"
CRI	90
Dimmable	Yes
Pack	24





2.5" Fixed Cylinder is compatible with mounting accessories listed below

Accessories



Emergency LED Driver
 15W G-48410
 25W G-95525
 30W G-48411
 60W G-95521



New Construction Plate
 G-98800 (2) Punch Out
 To use with Recessed Mount Installations



G-05110 10FT Pendant Cord
 Compatible with Pendant Options

- Selectable Color
- CRI 90+ True Colors
- Wet Location
- Air Tight
- Dimmable
- Adjustable Beam Angle
- IC Rated

Mounting Options



G-25070

CYD/25/RD/MP/SM/WH
Surface Mount Monopoint



G-25060

CYD/25/RD/MP/RCM/WH
Recessed Mount Monopoint
 CUT OUT 2.00"



G-25080

TR/25/H/ADAPTER WH
H Track Adapter



G-25050

CYD/25/RCM/WH
Recessed Mount J-Box
 CUT OUT 2.00"

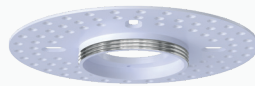

G-25051

25/CYD/25/TL/MP
J-Box Mud Plate



G-12510

CYD/25/RD/SM/WH
Surface Mount Canopy



G-12550

CYD/25/RD/CM/WH
Conduit Mount Canopy



G-12520

CYD/25/RD/SM/PDT/WH
Surface Mount Pendant
 8FT Adjustable



G-12530

CYD/25/RD/RCM/PDT/WH
Recessed Mount Pendant
 8FT Adjustable
 CUT OUT 2.00"



G-12540

CYD/25/RD/SM/STM/WH
Surface Mount Stem
 4X12" & 2X6" Stems

Dimensions: Dimensions below, display the Beam Adjustable cylinder with mounting accessories combined. Fixed cylinders dimensions can be found on its spec sheet.

G-25070

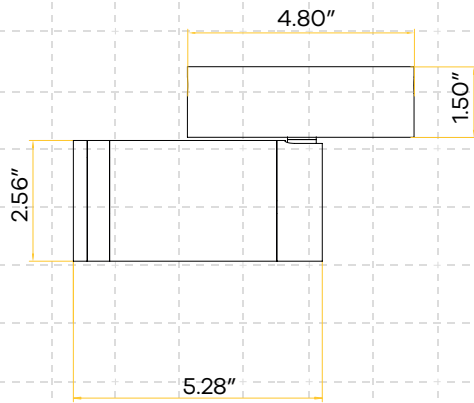

G-25060

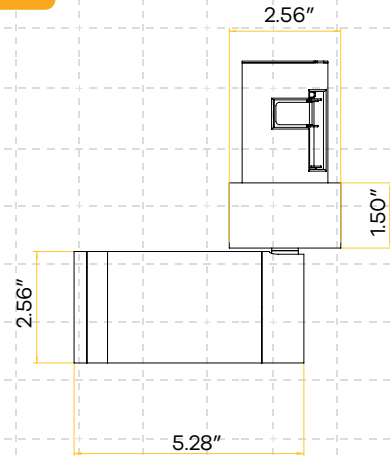

G-25080

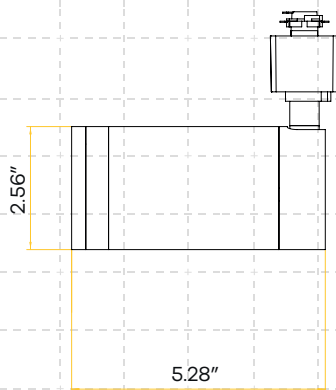

G-25050

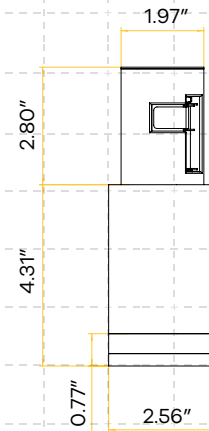

G-25051

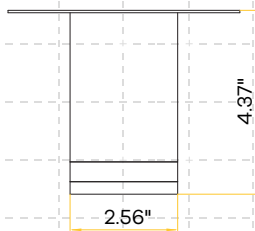

G-12510

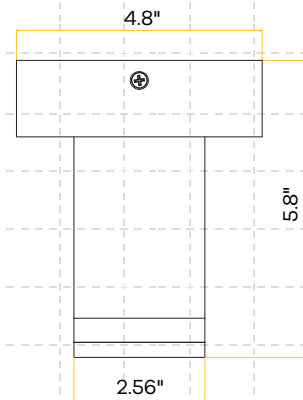

G-12550

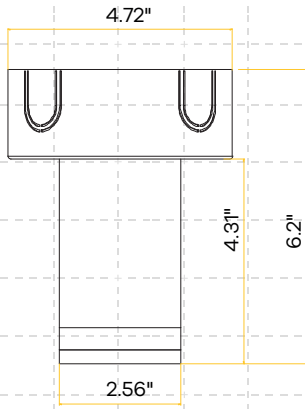

G-12520

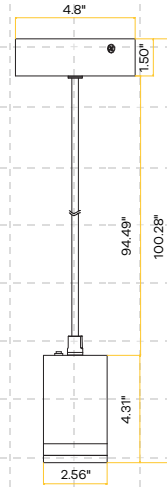

G-12530

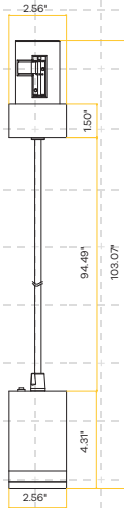

G-12540

