

Aster Pro Gimbal edition delivers seamless architectural integration with an exceptional 98 CRI, 6 finishes, 2 trim styles, universal 120/277V dual-voltage capability, and multi-protocol dimming.

Installation / Housing

- New construction / Remodel
- Flat pan Frame / Hanger bar Frame
- Driver is serviceable from below the ceiling for post installation
- Flanged or flangless

Rating and Certifications

- Air Tight Rated (Selective)
- IC Rated (Selective)
- Wet Location Rated (Module & Trim only)
- Title 24-JA8 Compliant
- ETL Listed
- FCC

Trims

- Flanged
- Flangless

Performance

Lumens	Up to 2720 Delivered Lumens
Beam angle	35°, 42°, 53° and 78° beam angle options
CRI	98+

Power Specifications

Input volts	120-277V
Output volts	33-38V
Dimming	Triac Phase / ELV / 0-10V (5%)

Kelvin

- 2700k
- 3000k
- 3500k
- 1800K-3000k Warm Dim

Beam Angle

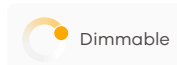
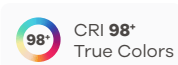
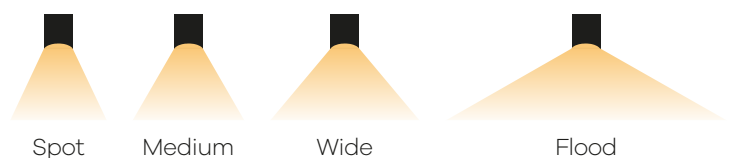

3" Gimbal Architectural Downlight Product Builder

Order Product Number

Model	Mounting	Flange Style	Watt
AP3.0GL	NC New construction pan	TM Trimmed (flanged)	12 12 Watt
	NCB New construction pan with bracket	TL Trimless – Mud-in* ¹	15 15 Watt
	RM Remodel		28 28 Watt* ²

Kelvin	CRI	Optic
27 2700K	98 CRI 98	CL Clear lens
30 3000K		FR Frost optic* ⁴
35 3500K		SIR Silver reflector* ⁵
DTW Warm dim (1800K - 3000K)* ³		

Beam	Media (optional)	Finish
NS Narrow spot 35°	HC Honeycomb	WH White
MS Medium spot 42°	SL Solite	BL Black
WS Wide spot 53°	PR Prismatic	BZ Bronze
WFL Wide flood spot 78°	LR Linear	BN Brushed Nickel
		BB Brushed Brass
		BC Brushed Copper

Notes

- ***1** Available in white or black finishes only
- ***2** Not IC (insulation contact) rated
- ***3** Available at 12w or 15W only.
- ***4** Available in 78° only.
- ***5** Available in 35 or 53° only.

Optic and Media

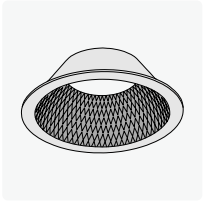

Silver reflector

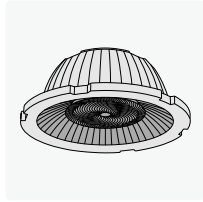

Clear lens

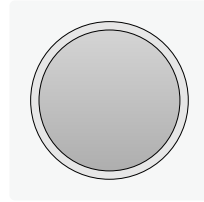

Frost optic

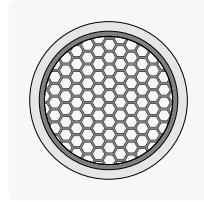

Honeycomb

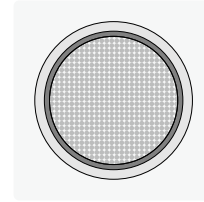

Solite

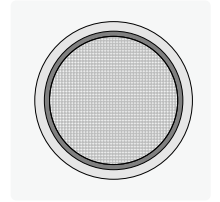

Prismatic

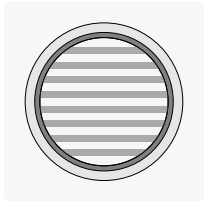

Linear

Trim Finish



WH White



BL Black



BZ Bronze



BN Brushed Nickel

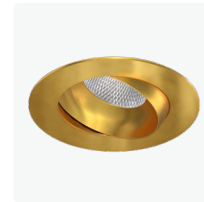

BB Brushed Brass

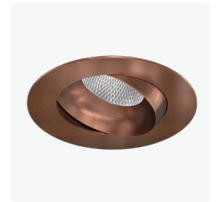

BC Brushed Copper

Trim Options

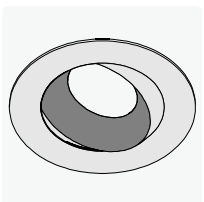

Flanged

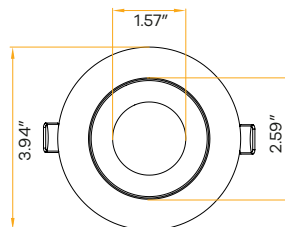
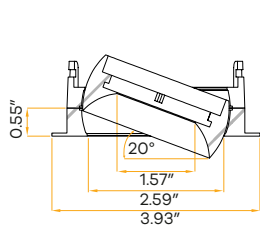

12W

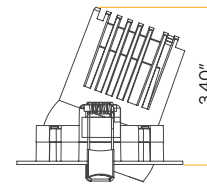

15/18W

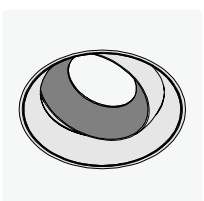
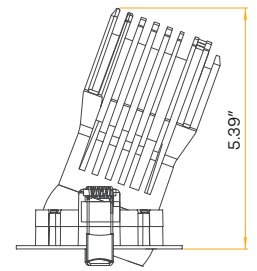

Gimbal Trimless

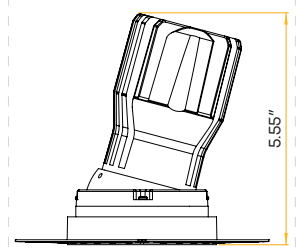
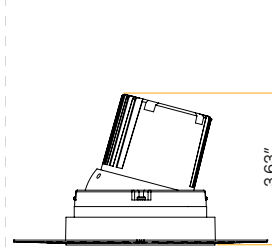
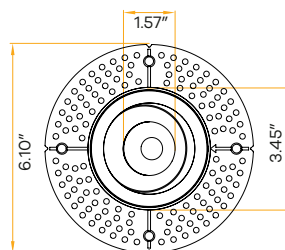
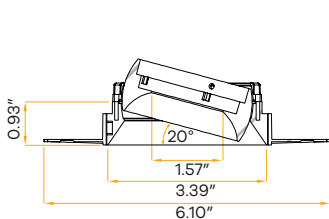
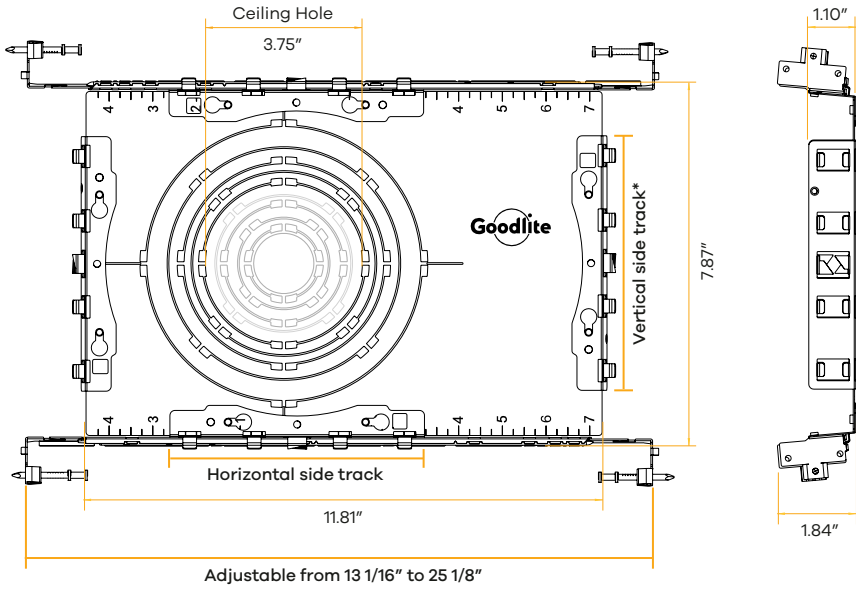

Plate Line Drawings

New Construction Pan With Bracket



*Note: Bracket can be shortened to 7.87" while using vertical side tracks

New Construction Pan

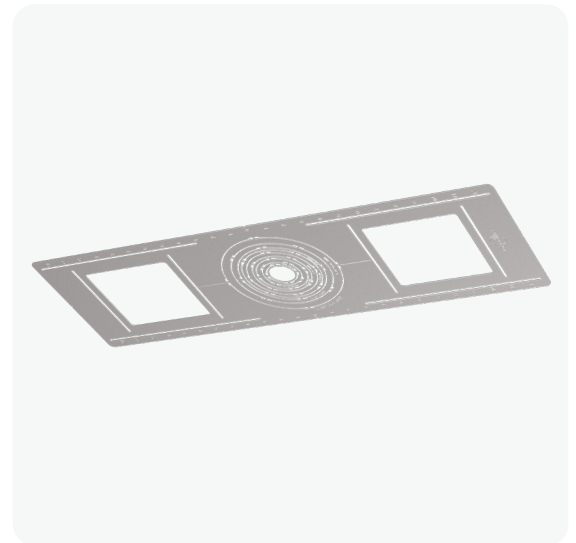
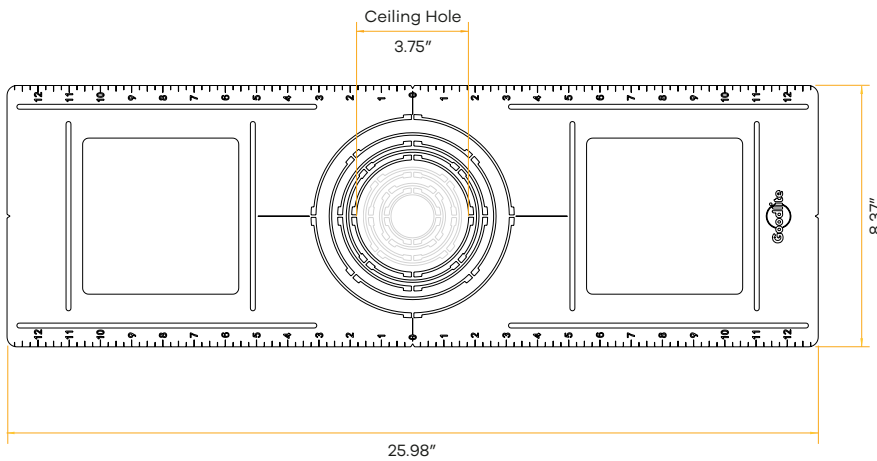

Engine Line Drawing

12W Driver

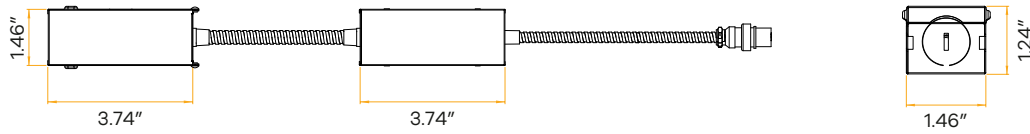

15W Driver

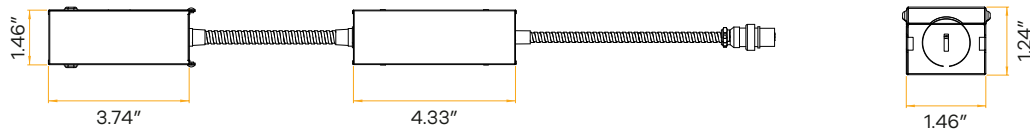

28W Driver

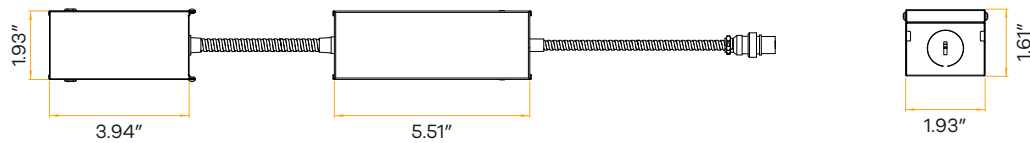

Dimmer Compatibility List

Brand	Load	Model	Brand	Load	Model
LUTRON	150W	LECL-153P	LUTRON	300W	DVELV-300P
		CTCL-150H		SELVB-300P	
		LGCL-153PLH		600W	MACL-153M
		CTCL-153P		MRF2-600M	
		SCL-153P		DVLV603	
		PD-6WCL		MA-600	
		PD-5NE	LEVITON	150W	IPL06
		DVCL-153P		6672	
		TGCL-153P		6674	
		AYCL-153P		RDL06-10Z	
	MSCL-OP153M	RNL06-10Z			
	STCL-153M	300W		DSL06-1LZ	
	DVRF-6L	D26HD			
	250W	PD-10NXD	PASS & SEYMOUR	250W	LSCL450W
		DVCL253	WSCL450W		
		DVRP-253	EATON	300W	DDE06-BLZ
		MRF2S-6CL	AAL06		

0-10V Dimming

Brand	Model
LUTRON	DVSTV
	DVSCTV
LEVITON	IP710-DLZ
	DS710-10Z
LEGRAND	RH4FBL3P
COOPER	SF10P

Delivered Lumens Matrix

White Trim 98CRI Report

Wattage	Color Temperature	Clear Lens			Silver Reflector	
		35°	42°	53°	33°	54°
12W	2700K (98CRI)	896LM	893LM	986LM	1001LM	1007LM
	3000K (98CRI)	1016LM	1012LM	1115LM	1098LM	1127LM
	3500K (98CRI)	1014LM	1012LM	1122LM	1136LM	1161LM
15W	2700K (98CRI)	1129LM	1123LM	1286LM	1292LM	1335LM
	3000K (98CRI)	1306LM	1290LM	1452LM	1433LM	1466LM
	3500K (98CRI)	1282LM	1280LM	1458LM	1472LM	1550LM
28W	2700K (98CRI)	2220LM	2141LM	2417LM	2431LM	2443LM
	3000K (98CRI)	2508LM	2447LM	2701LM	2645LM	2691LM
	3500K (98CRI)	2484LM	2418LM	2668LM	2720LM	2773M