



Aster Pro Round Trimless edition delivers seamless architectural integration with an exceptional 98 CRI, 5 finishes, compatible with either drywall or millwork ceilings, universal 120/277V dual-voltage capability, and multi-protocol dimming.

### Installation / Housing

- New construction / Remodel
- Flat pan Frame / Hanger bar Frame
- Driver is serviceable from below the ceiling for post installation
- Drywall / Millwork Ceiling Compatible

### Rating and Certifications

- Air Tight Rated (Selective)
- IC Rated (Selective)
- Wet Location Rated (Module & Trim only)
- Title 24-JA8 Compliant
- ETL Listed
- FCC

### Ceilings

- Drywall
- Millwork

### Performance

Lumens	Up to 2720 Delivered Lumens
Beam angle	35°, 42°, 53° and 78° beam angle options
CRI	98+

### Power Specifications

Input volts	120-277V
Output volts	33-38V
Dimming	Triac Phase / ELV / 0-10V (5%)

### Kelvin

- 2700k
- 3000k
- 3500k
- 1800K-3000k Warm Dim

### Beam Angle

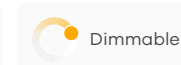
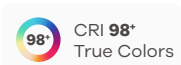
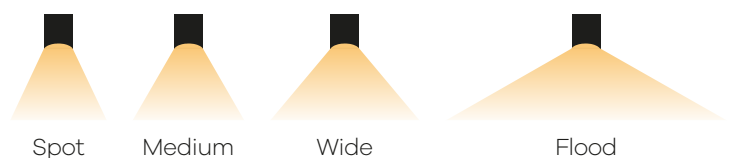

### 3" Round Trimless Architectural Downlight Product Builder

Order Product Number

Model	Mounting	Ceiling Material	Watt
AP3.ORDTL	<b>NC</b> New construction pan	<b>DRW</b> Drywall Mud-in	<b>12</b> 12 Watt
	<b>NCB</b> New construction pan with bracket	<b>MW</b> Millwork trimless	<b>15</b> 15 Watt
	<b>RM</b> Remodel		<b>28</b> 28 Watt <sup>*1</sup>

Kelvin	CRI	Optic
<b>27</b> 2700K	<b>98</b> CRI 98	<b>CL</b> Clear lens
<b>30</b> 3000K		<b>FR</b> Frost optic <sup>*3</sup>
<b>35</b> 3500K		<b>SIR</b> Silver reflector <sup>*4</sup>
<b>DTW</b> Warm dim (1800K - 3000K) <sup>*2</sup>		

Beam	Media (optional)	Finish
<b>NS</b> Narrow spot 35°	<b>HC</b> Honeycomb	<b>WH</b> White
<b>MS</b> Medium spot 42°	<b>SL</b> Solite	<b>BL</b> Black
<b>WS</b> Wide spot 53°	<b>PR</b> Prismatic	<b>BZ</b> Bronze
<b>WFL</b> Wide flood spot 78°	<b>LR</b> Linear	<b>BN</b> Brushed Nickel
		<b>BB</b> Brushed Brass

#### Notes

- \*1 Not IC (insulation contact) rated.
- \*2 Available at 12w or 15W only.
- \*3 Available in 78° only.
- \*4 Available in 35 or 53° only.

### Optic and Media

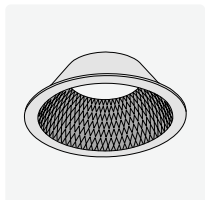

Silver reflector



Clear lens

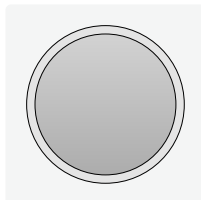

Frost optic

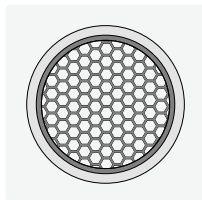

Honeycomb

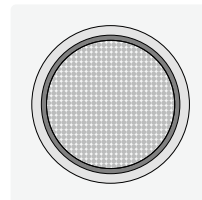

Solite

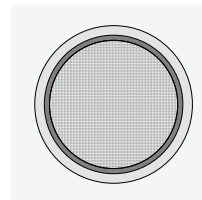

Prismatic

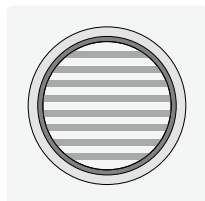

Linear

### Trim Finish



WH White



BL Black



BZ Bronze



BN Brushed Nickel



BB Brushed Brass

### Trim Options

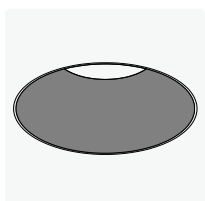

Drywall

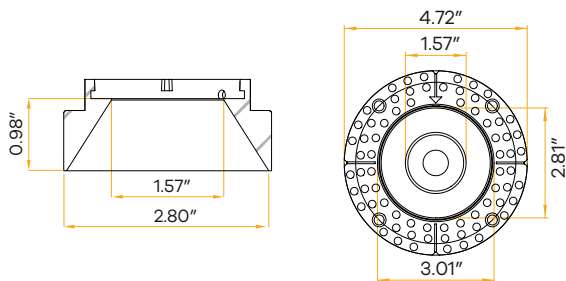

12W

15/18W

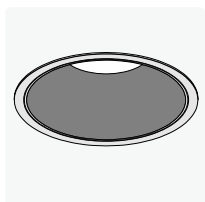
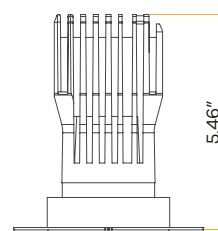
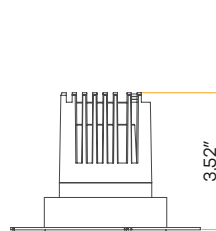

Millwork

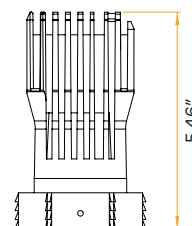
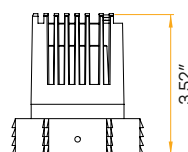
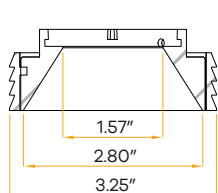

## Plate Line Drawings

### Construction Pan With Bracket - For Drywall use

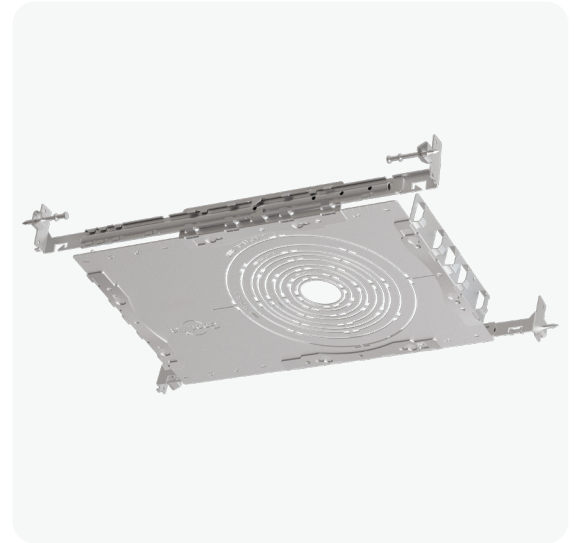
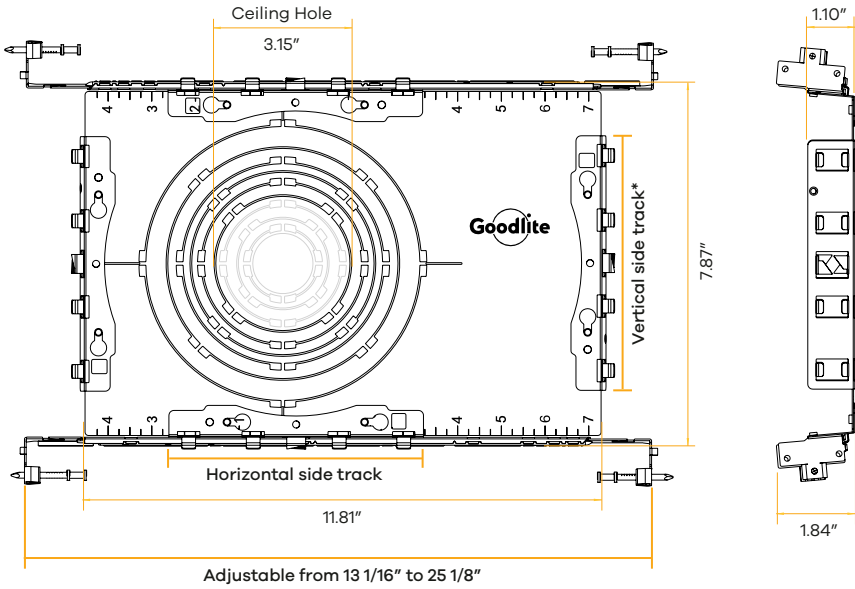

\*Note: Bracket can be shortened to 7.87" while using vertical side tracks

### Construction Pan - For Drywall use

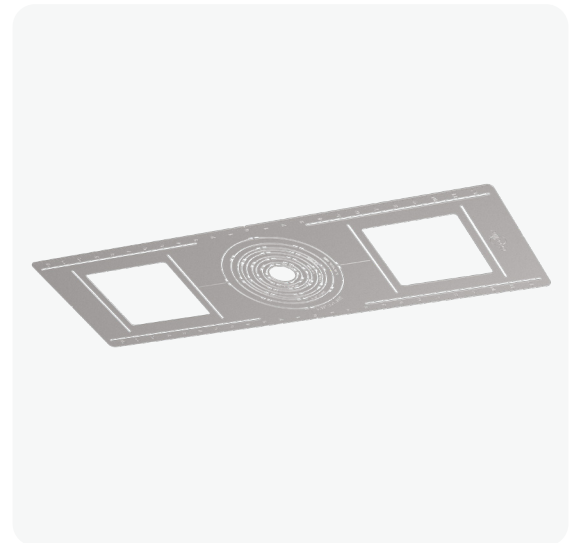
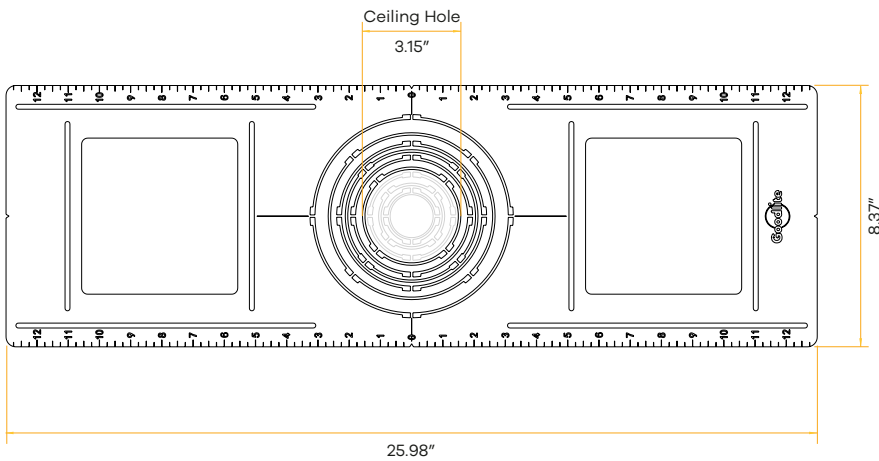

## Engine Line Drawing

### 12W Driver

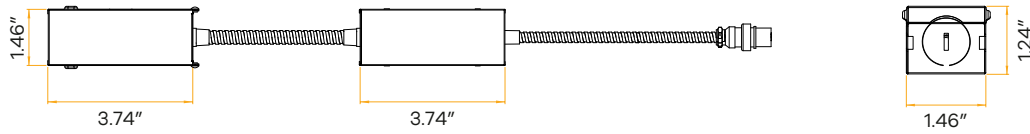

### 15W Driver

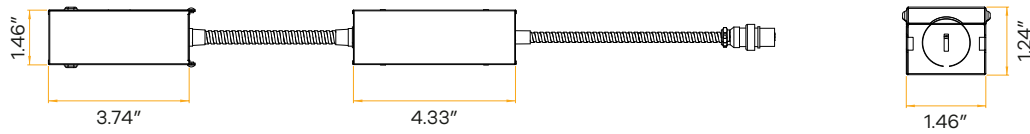

### 28W Driver

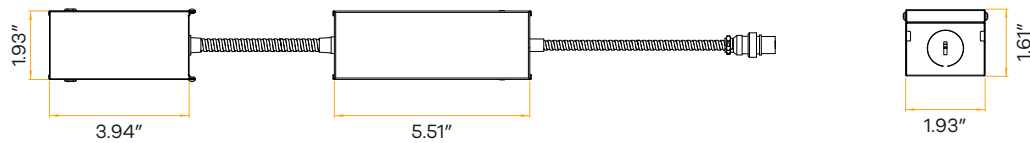

## Dimmer Compatibility List

Brand	Load	Model	Brand	Load	Model
LUTRON	150W	LECL-153P	LUTRON	300W	DVELV-300P
		CTCL-150H		SELVB-300P	
		LGCL-153PLH		600W	MACL-153M
		CTCL-153P		MRF2-600M	
		SCL-153P		DVLV603	
		PD-6WCL		MA-600	
		PD-5NE	LEVITON	150W	IPL06
		DVCL-153P		6672	
		TGCL-153P		6674	
		AYCL-153P		RDL06-10Z	
		MSCL-OP153M		RNL06-10Z	
		STCL-153M		300W	DSL06-1LZ
	DVRF-6L	D26HD			
	250W	PD-10NXD	PASS & SEYMOUR	250W	LSCL450W
		DVCL253	WSCL450W		
		DVRP-253	DDE06-BLZ		
		MRF2S-6CL	EATON	300W	AAL06

### 0-10V Dimming

Brand	Model
LUTRON	DVSTV
	DVSCTV
LEVITON	IP710-DLZ
	DS710-10Z
LEGRAND	RH4FBL3P
COOPER	SF10P

### Delivered Lumens Matrix

#### White Trim 98CRI Report

Wattage	Color Temperature	Clear Lens			Silver Reflector	
		35°	42°	53°	33°	54°
12W	2700K (98CRI)	896LM	893LM	986LM	1001LM	1007LM
	3000K (98CRI)	1016LM	1012LM	1115LM	1098LM	1127LM
	3500K (98CRI)	1014LM	1012LM	1122LM	1136LM	1161LM
15W	2700K (98CRI)	1129LM	1123LM	1286LM	1292LM	1335LM
	3000K (98CRI)	1306LM	1290LM	1452LM	1433LM	1466LM
	3500K (98CRI)	1282LM	1280LM	1458LM	1472LM	1550LM
28W	2700K (98CRI)	2220LM	2141LM	2417LM	2431LM	2443LM
	3000K (98CRI)	2508LM	2447LM	2701LM	2645LM	2691LM
	3500K (98CRI)	2484LM	2418LM	2668LM	2720LM	2773LM