

REGULUS 4" RGBWW REGRESS SLIM

INSTALLATION INSTRUCTIONS

- 1 IMPORTANT** Read all instructions before installing plate. Retain for future reference.
- 2 SAFETY:** Turn the power at off main fuse/breaker panel before attempting any electrical work. This luminaire must be wired in accordance with local electrical codes and ordinances. Grounding connections should be done in the detachable junction box.
- 3 WARNING:** Make sure the power is OFF from the electrical panel before starting or installation attempting any maintenance.

DRIVER	Model	G-20441
	Input	120-277 V AC 50/60Hz
	Output	33-38V DC 350mA
	Lamp Life	50000 Hours
	Operating Temperature	-40°C to +40°C
	DC Wire Type	FT6 DC Wire
	Wire Space	10 Cubic inch
	Energy used	15W
LIGHT	Luminous Flux	900lm AT CCT
	Equivalent to:	100W halogen
	Beam Angle	110 Degree
	CRI	Ra>90
	Approved Location	Wet

Installation

1. Nail-in the mounting plate to the ceiling joist. Measure the position of the opening on the mounting plate from each wall. (Fig.1)
2. Install the drywall on to the ceiling. (Fig.2)
3. Cut-out a circle where the mounting plate opening is located. (Fig.3)
4. Pull the supply wire through the cut-out hole. Do the electrical supply connection in the detachable junction box (Note: A licensed electrician must do the connections as per the local electrical code). Insert the junction box into the ceiling. (Fig.4)
5. Connect the junction box's DC connector to the Tuya control module's connector. (Fig.5)
6. Connect the Tuya control module's DC connector to the yellow RGB module's DC connector.
7. **New construction applications:** Hardwire box shall be firmly secured to studs, joists, or similar fixed structural units
8. **Remodel applications:** Do not require the hardwire box to be firmly secured after the mounting plates, studs, joists, or structural units that have been concealed. Snap off the hardwire box tabs then insert into ceiling FIG 4
9. Push the spring clips upwards and push the luminaire into the cut hole of the ceiling. Release the spring clips and align the luminaire to sit properly over the ceiling cut hole. (Fig.6)
10. Switch on the supply breaker and turn on the luminaire.

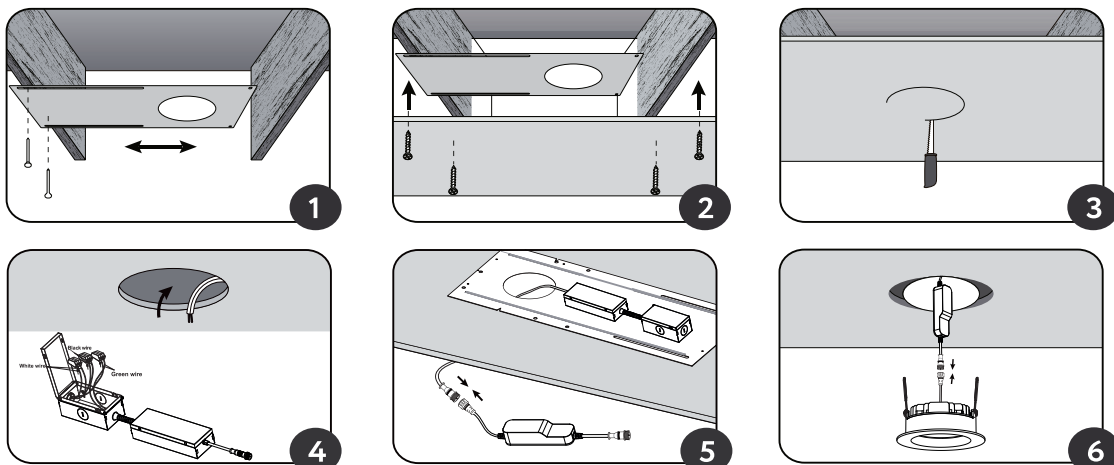

WARNING: DO NOT USE ANY OTHER DRIVERS EXCEPT THE DRIVERS THAT ARE INCLUDED WITH THE FIXTURE. DO NOT CONNECT MULTIPLE FIXTURES TO ONE DRIVER. DO NOT OPEN THE LIGHT FIXTURE OR THE SIDE PLATES OF THE DRIVER - NO SERVICEABLE PARTS INSIDE.

MANUFACTURER'S LIMITED WARRANTY

Your Product, when delivered to you in new condition and in original packaging, is warranted against defects in materials and workmanship as follows for a period of 3 years from the date of the original purchase. Defective products returned and proven to be defective upon inspection will be repaired, replaced with a new Product or a credit will be issued against original invoice at the discretion of manufacturer.

To avoid any doubt, "the replacement Product" does not include any removal or installation costs or expenses, including without limitation labor costs or expenses, shipping costs to return defective products or any damages that may occur during the return of product. This limited warranty is subject to the following additional conditions:

1. Products must have been installed and operated in accordance with manufacturer's instructions.
2. Products have not been subjected to accident, neglect, abuse, misuse, lightning, electrical surges or acts of God.
3. The Product has been purchased directly from an authorized distributor.
4. Purchase receipt or invoice is available for inspection.
5. This warranty is limited to Products purchased for use in regions that are within jurisdiction of Canada and USA.

This device complies with part 15 of the FCC rules. Operation is subject to the following two conditions:

- (1) This device may not cause harmful interference.
- (2) This device must accept any interference received, including interference that may cause undesired operation.

THE FOREGOING WARRANTY IS EXCLUSIVE, AND THE SOLE REMEDY FOR ANY AND ALL CLAIMS. IN NO EVENT WILL THE MANUFACTURER BE LIABLE FOR ANY SPECIAL, COMPENSATORY, INDIRECT, PUNITIVE, OR INCIDENTAL OR CONSEQUENTIAL DAMAGES INCLUDING, WITHOUT LIMITATION, DAMAGES RESULTING FROM LOSS OF USE, PROFITS, BUSINESS OR GOODWILL, WHETHER OR NOT THE MANUFACTURER HAS BEEN ADVISED OF THE POSSIBILITY THEREOF.

RGBCCT Downlight controller

INSTRUCTIONS, WIRING DIAGRAM, FEATURES, WARRANTY

Remote	Model	G-20441
	Energy	Battery included
	Control distance	100 ft
	Max device control	Limitless
	Total zone	4
	RGBCCT	RGB-16,000,000 Colors - CCT 27-65K

RF

RF Linking Instructions

- 1 Turn on the light
- 2 
Within 30 seconds, press and hold one of the Group buttons – A, B, C, or D – for more than 5 seconds.
- 3 The indicator light on the remote will flash, confirming the light has been added to the selected group.

RF Unlinking Instructions

- 1 Turn on the light
- 2 
Press and hold the same Group button (A, B, C, or D) together with the button "-" for more than 5 seconds.
- 3 The light will be removed from that group.

Remote Guide

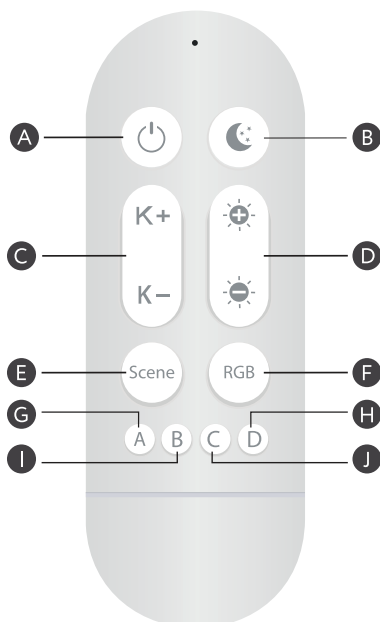

	Description	Function
A	Power Switch	Turns lights on or off
B	Night Lamp	Activates a soft night light (used to set timer mode)
C ₁	K+	1 Increases color temperature (in steps or gradually)
C ₂	K-	2 Decreases color temperature (in steps or gradually)
D ₁	Brightness +	1 Increases brightness (in steps or gradually when held)
D ₂	Brightness -	2 Decreases brightness (in steps or gradually when held)
E	Scene Selection	Cycles through presets: Good Night, Reading, Working, Relax.
F	RGB Color Mode	Cycles through colors (Red/Orange/Yellow/Green/Cyan/Blue/Purple)
G	Group A	Assigns or controls lights (Group A)
H	Group B	Assigns or controls lights (Group B)
I	Group C	Assigns or controls lights (Group C)
J	Group D	Assigns or controls lights (Group D)

Wi-Fi linking instructions

Wi-Fi

Turn the light on and off 5 times
 - on - off - on - off - on - off - on - off - on.
 Wait until the light blinks quickly
 Then open the app and link the light
 If the device hasn't been recognized then
 click + and add manually
 Once linked to the app, the remote can
 be paired.

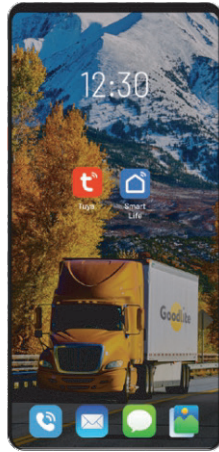

Install / Login to the app

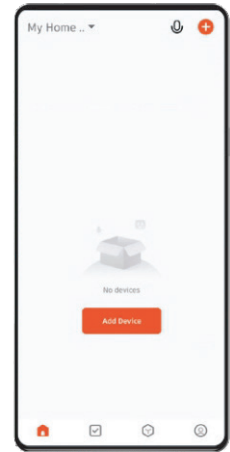

Enter the Tuya app & add the Downlight

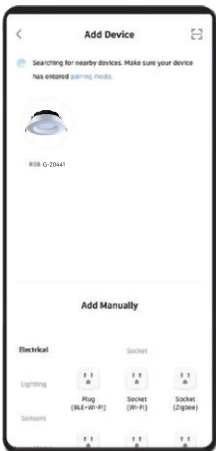

Once Controller has been recognized Tap device symbol to be added

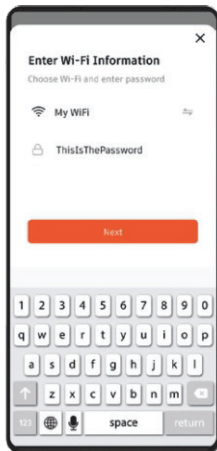

Enter your Wi-Fi information

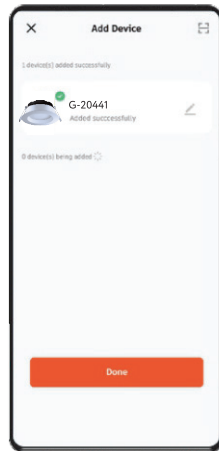

Once device has been successfully added Tap "Done" to enter device control



You have successfully entered the device control. Tap on symbol to turn on the light

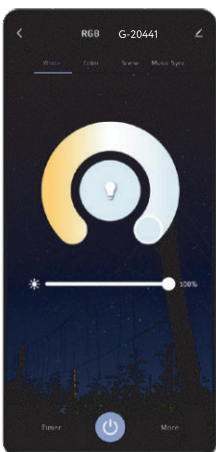

CCT CONTROL

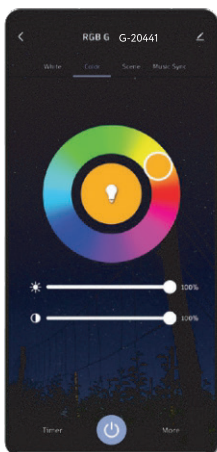

RGB CONTROL

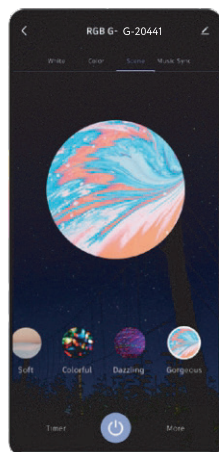

RGB PRESET SCENE



RGB MUSIC SCENE

1. Grouping multiple controllers instructions

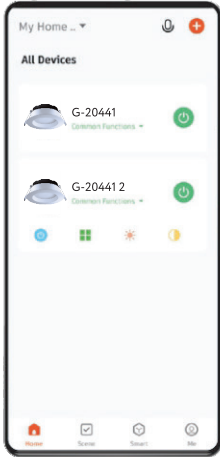

Open the app to home screen & select 1 controller symbol

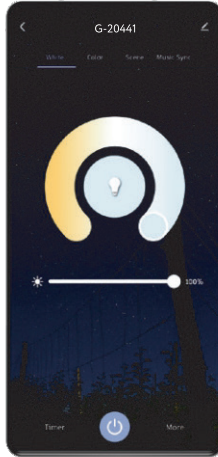

Tap the edit button located in the right top corner

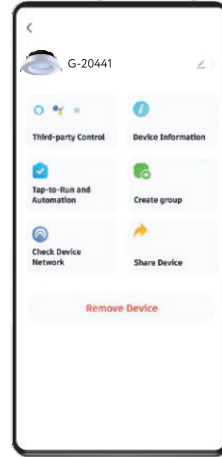

Select create group option

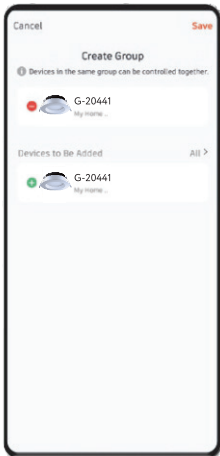

Add the controller's you'd like to have in the group

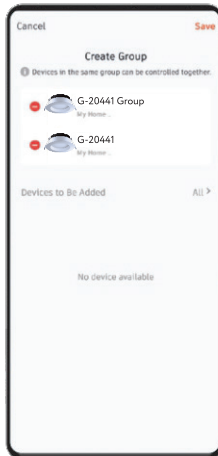

Once selected tap save located in the right top corner

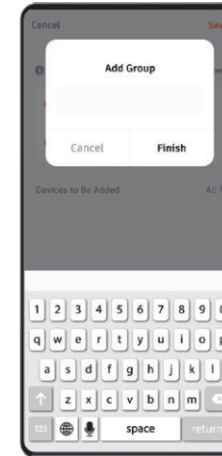

Rename the group to your liking

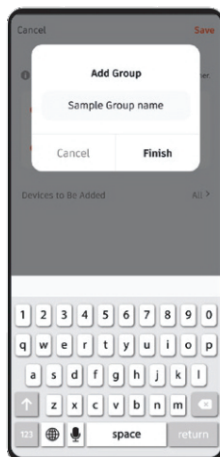

Tap finish once renamed

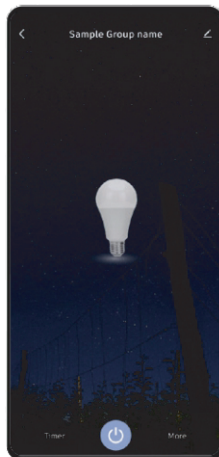

You have successfully created and entered the new group

1. One Zone can synchronously control unlimited controllers, as long as each controller is within 100 feet of the next.
2. One downlight can be controlled & linked simultaneously to up to 3 other remotes
3. One downlight can be controlled & linked simultaneously via Wi-Fi app & RF remote

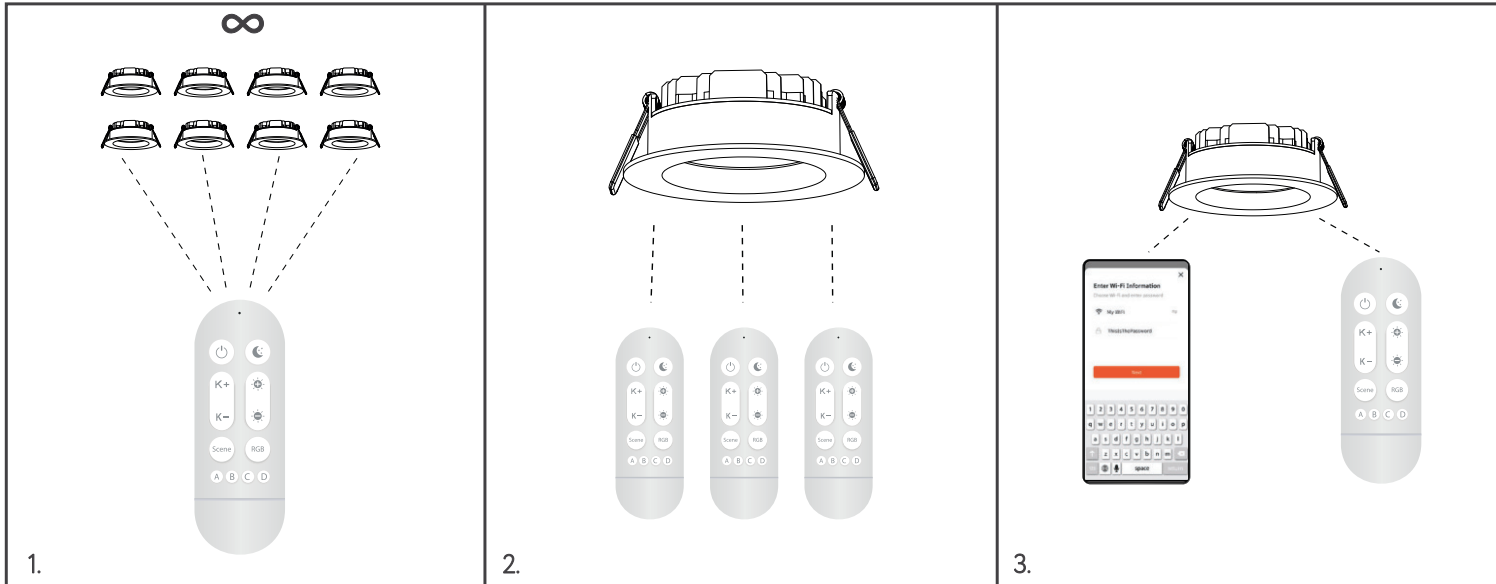

Frequently Asked Questions

1. Why can't the remote control the light after I've connected it to the app?

Once the light is connected to the app (such as Tuya or SmartLife), the app takes priority. You must first disconnect the light from the app before it can be controlled with the remote again.

2. Why doesn't the remote respond at all?

Make sure the light has power and is not already connected to another app or remote. Also, check that you are within range and that the battery in the remote is not depleted.

3. Why is the pairing process failing?

Ensure that you're pressing the Group button within 30 seconds of powering on the light. If too much time passes, restart the process by turning the light off and on again.

4. Can I pair the same remote with multiple lights?

Yes, you can pair multiple lights to the same remote. Assign them to the same group (A, B, C, or D) to control them together, or use separate groups to control them individually.

5. Can one light be controlled by multiple remotes?

Yes, but only up to 3 remotes. If a fourth is added, one of the existing pairings will be overwritten.

6. What should I do if I want to control the light with both the app and the remote?

Currently, the light cannot be controlled by both the app and the remote at the same time. You must disconnect from the app before using the remote.

7. What does it mean if the indicator is blinking?

A blinking indicator means the light is in pairing or unpairing mode. It will continue blinking until the process is completed successfully.

8. How can I cancel the timer mode?

Press and hold the Night Lamp button and the ON/OFF button at the same time to cancel the active timer.

9. The colors are not changing correctly in RGB mode. What do I do?

Make sure you are pressing the RGB button, not a Scene or CCT button. If it still doesn't work, reset the light and try again.