

Altair 3.5 Four Head Trimless Instruction sheet

INSTALLATION INSTRUCTIONS AND WARRANTY INFORMATION

- ⓘ IMPORTANT** Read all instructions before installing the plate. Retain for future reference.
- ⚠ SAFETY:** Turn the power off at main fuse/breaker panel before attempting any electrical work. This Luminaire must be wired in accordance with local electrical codes and ordinances. Grounding connections should be done in the detachable junction box.
- ⚠ WARNING:** Make sure the power is OFF from the electrical panel before starting installation or attempting any maintenance.

INSTALLATION INSTRUCTIONS:

1. Measure distance from walls and mark position of fixture to be installed on ceiling
2. Carefully scribe hole template, in accordance to cut hole size on desired location.
3. Carefully cut a hole in the ceiling (Fig. 1).
4. Follow steps 1 through 4 under "electrical connections".
5. Connect driver enclosure to engine by connector.
6. Pass the driver enclosure and attached bx cable through the hole and place it on a straight surface inside the ceiling cavity.

ELECTRICAL CONNECTIONS:

1. Provide electrical service according to your local electrical code for a suitable junction box. Supply wire insulation must be rated for at least 90°C (Fig. 2).
2. Remove the driver enclosure cover. Remove the appropriate knock-out(s) to accommodate the type of electrical service to be used (Fig. 3).
3. Insert electrical supply cable through knock-out in the driver enclosure and secure with cable connector. Wire enclosure using pre-installed push-in connectors. Do the wiring as per NEC (National Electric Code) standards. Connect green ground wire of cable to green wire on fixture. Connect white wire of the cable to white wire of the fixture. Connect black wire of cable to black wire of fixture (Fig. 4).
4. If using 0-10V dimming, connect matching purple and gray wires with the supplied block connector.
5. Place all wiring and connections back in the driver enclosure and replace the cover.

1. Follow steps 1 through 5 under "electrical connections".
2. Align the mesh adapter with the drywall hole and screw in place (Fig.5). Ensure to pull the driver lead through the trimless adapter for engine install.
3. Plaster over the trimless mesh adapter, be careful not to fill past raised trim (Fig.6).

- and twist the cap of the connector well (Fig.7).
5. Hook the steel wire rope into the frame hole. Insert cable and engine into trimless mesh adapter opening
 6. Push the Fixture into the mesh in the right direction. After installing the fixture, please check if the fixture is well-fixed (Fig.8) **NEW FEATURE, Easy removal:** Simply push the installed light fixture into the ceiling to disengage the locking mechanism, allowing for effortless removal.

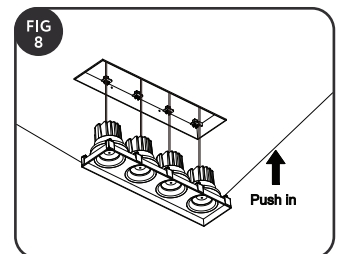
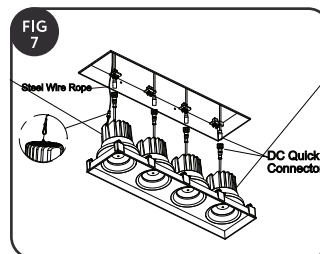
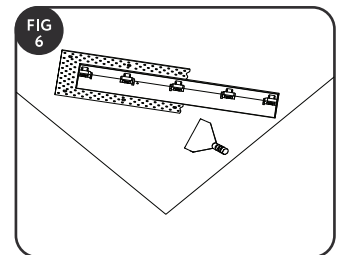
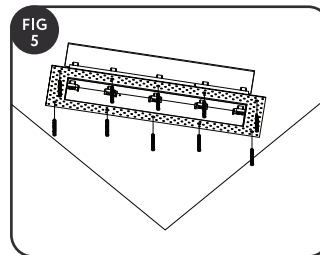
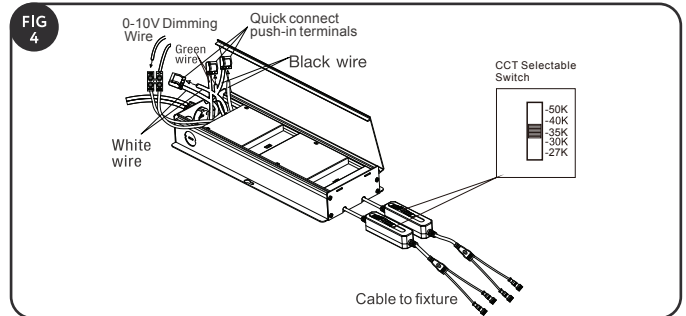
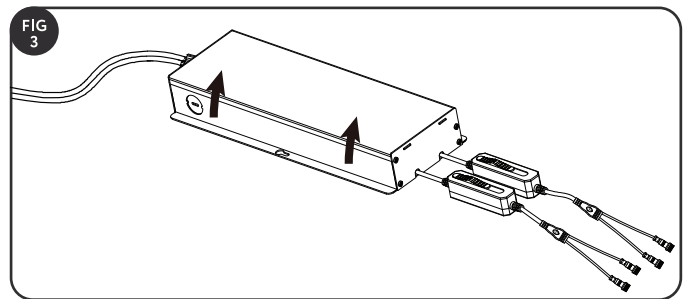
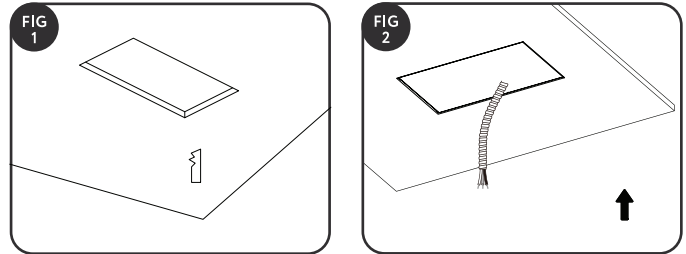

Hole Cut Size / Taille Trou Découpé	
G-98764/G-98774	15.12"x3.94" (384mm x 100mm)

G-98764 & G-98774 Relevant Parameters

DRIVER	Model	G-98764 & G-98774
	Input	120-277 V AC 50/60Hz
	Output Voltage	33-38V DC
	Output Current	1260MA/1850MA
	Lamp Life	50000 Hours
	Operating Temperature	-20°C to +40°C
	Dimming	Triac dimming (120V AC input only) 0-10V dimming (120-277V AC input)
LIGHT	Energy used	50W(IC Rated) / 80W(NON-IC)
	Luminous Flux	50W(4900LM) / 80W(6800LM)
	Equivalent to:	600W Halogen
	CCT Options	2700K-3000K-3500K-4000K-5000K
	Beam Angle	40°/ head
	CRI	RA>90
	Approved Location	Wet Location
MOUNTING	Wire Space	14 Cubic inch
	OD	17.24"x6.02"(438mm x 153mm)
	Thickness	4.25"(108mm)
	Cut Out	15.12"x3.94"(384mm x 100mm)

Dimmer Compatibility List for LED Recessed Lights. Dimmable down to 10%					
Brand	Family	Model	Load (W)	50W(IC Rated)	80W(NON-IC)
LUTRON	Skylark Contour	LECL-153P	150W	2	1
		CTCL-150H	150W	2	1
		LGCL-153PLH	150W	2	1
		CTCL-153P	150W	2	1
		SCL-153P	150W	2	1
		S-600P	600W	3	2
	Caseta	PD-6WCL	600W	3	2
		PD-5NE	150W	2	1
		PD-10NXD	250W	3	2
		DIVA	DVCL-153P	150W	2
Toggler		TGCL-153P	150W	2	1
Ariadni	AYCL-153P	150W	2	1	
Maestro	MACL-153M	150W	2	1	
LEVITON	Illuminatech	IPL06	150W	2	1
	SureSlide	6672	150W	2	1
EATON	Smart Dimmer	AAL06	300W	3	2

Instruction for Changing the lens of ALTAIR Series Gimbal Downlight (Remark The default beam angle is 40° per head. Other beam angle lens are not included.)

1. Twist the LED module anticlockwise and take the trim part and LED module apart.
2. Taking out the plastic reflector and default lens.
3. Installing the silicone gasket into the slot well, then install your target beam angle lens back to module.
4. Put the plastic reflector onto the lens.
5. Twist the LED module clockwise and make sure the lens is well fixed.

