

Led Troffer G-98250 - G-98252

Installation Manual

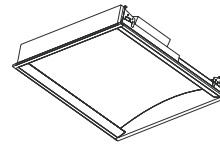

1 Disconnect the power before installation. Exploded view of completed assembly with component call out. 1, 2, 3, etc.

2 Loosen the screw in the backside channel board with screwdriver, use a screwdriver to enter in the rectangular groove on knock out, pull in the right or left side direction until the knock out comes off enabling you to proceed with the wiring connections.

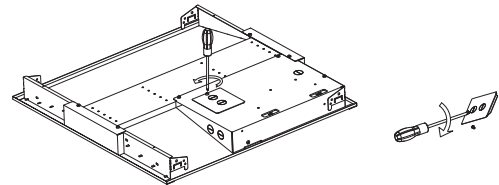

3 Through the conduit, the power feed is connected to the wiring terminal; make sure the connection is solid and reliable.

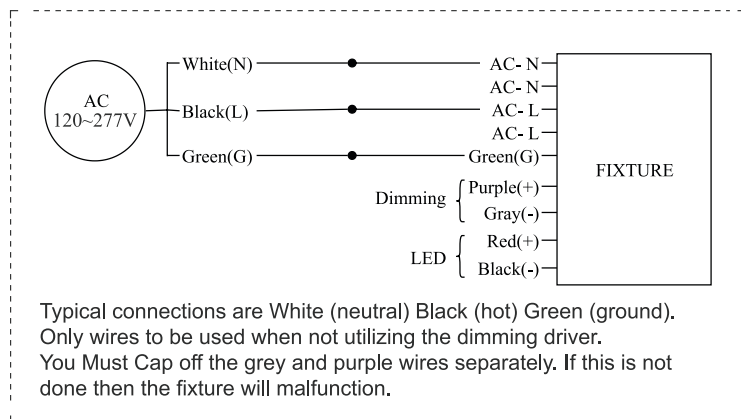
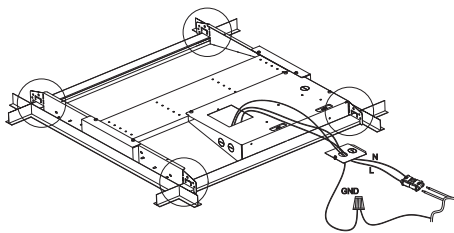

Wiring diagram

4 After the power is correctly connected, install the screw back to its channel board with screwdriver.

5 Put the LED fixture through the hole and put it on the T-shaped keel, then rotate the earthquake clips on the four fixture corners, as shown in the position in the figure, about 90°, and hang the fixture above the keel. This will protect the fixture from vibration.

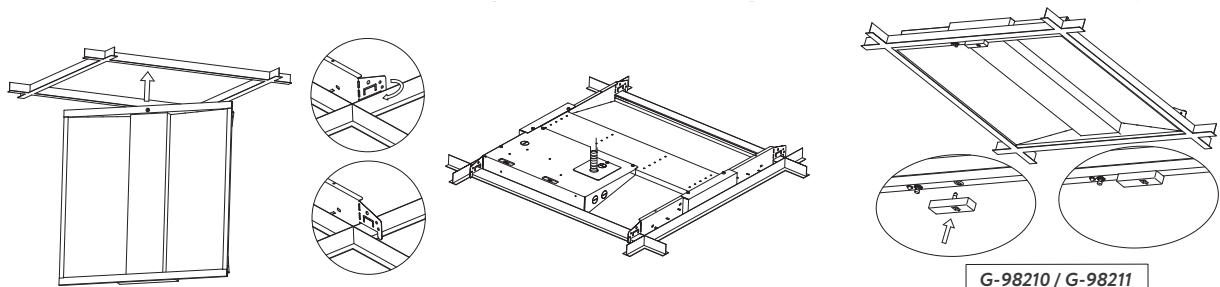

G-98210 / G-98211

6 Push Sensor (order separately) into the 12V DC power jack if needed.

7 Not IC rated, do not cover fixture. Operating temp: -4°F to 104°F